

Varenummer: 0101074  
 Beskrivelse: Seeger låsering A 57 DIN 471  
 Fjederstål  
 Note: Monteres med ZGA tang

## Mål

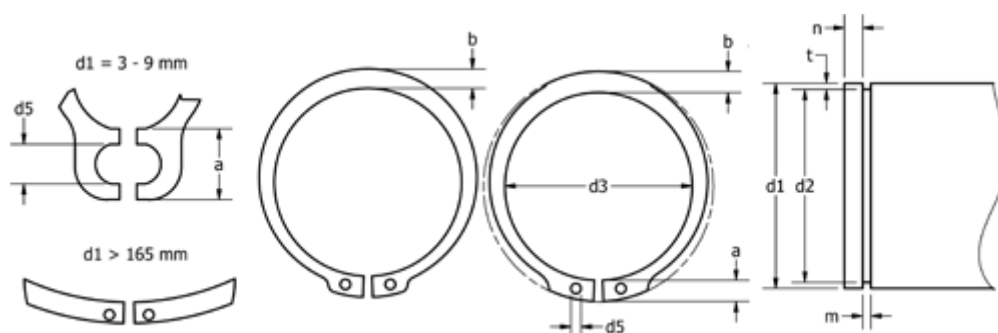

a max	= 7,3	FN kN	= 43.7	s	= 2.00
AN mm <sup>2</sup>	= 262.0	FRg kN	= 11.40	t	= 1.50
b	= 5.5	FR kN	= 70.90	Tang	= ZGA-3
Betegnelse	= A57	g	= 2.5	tol	= -0.07
d1	= 57	K kN-mm	= 128.00	tol	= +0,46-1,10
d2	= 54.0	m min	= 2.15	tol	= -0.30
d3	= 52.8	n abl x 1000	= 8.0	vægt kg/1000	= 12.200
d5 min	= 2.5	Nominel træk	= 4.5		